

Polygonal Paper

Instructions

on gluing the wolf mask from paper

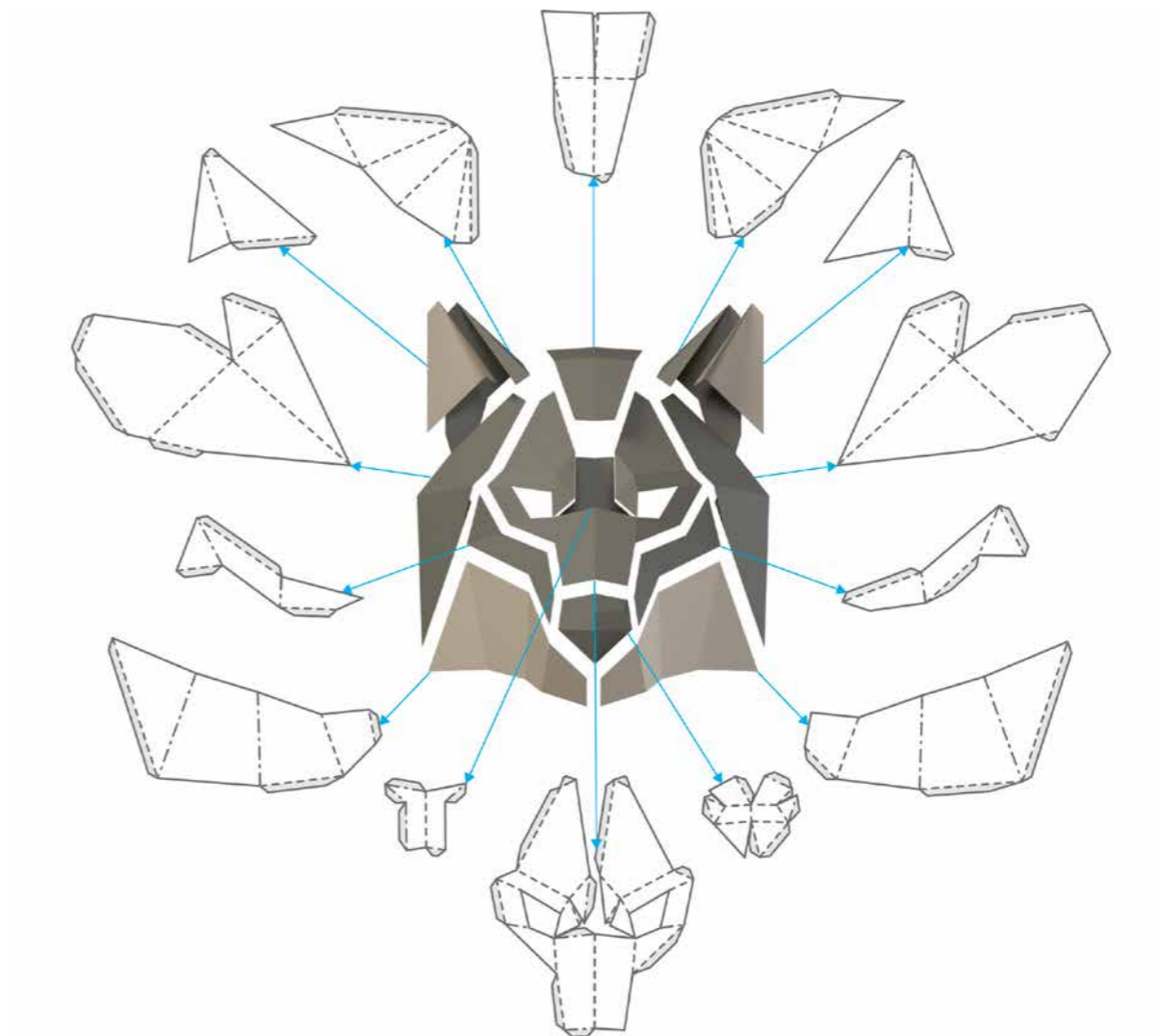



Author's note

Thank you for purchasing the files for making wolf mask!

You will need about 3-4 hours on gluing it. The size of mask universal for adults. Following the easily understandable instructions will make the creation of unique mask possible for any adult.

Video tutorial: <https://youtu.be/Y63wporZrkE>

Use of our intellectual property for profit is prohibited. All rights reserved.



Rim Shamsin and Design Team of Polygonal Paper

- ✉ info@polygonalpaper.com
- vk <https://vk.com/polygonalpaper>
- f <https://www.facebook.com/polygonalpaper>
- ig <https://www.instagram.com/polygonalpaper>
- Be <https://www.behance.net/polygonalpaper>



You will need for work



A cutter.

You can use any cutter for paper.



A ruler.

It's better to use the metal ruler, because this material is difficult to cut by cutter.



Glue.

Which does not deform the paper. Note that most of the PVA glues dries for a long time, and the paper gets wet from them, and then deformed. I like to use UHU glue for paper.



A surface for the cutting.

You can use a piece of old linoleum, or a glass panel, or a clean cutting board.



Template.

Printed on paper weights 200-300 gr. / sq.m. Please, do not use office paper (80-90 gr./ sq.m.). This paper is too thin. You can use aquarelle paper. This paper has a light texture, thanks to this gluing places of the finished model is almost unnoticeable. If you want get multicolor mask as in our instructions, print pages 1 and 2 on dark paper, and page 3 print on light paper.



Elastic ribbon.

We use simple elastic band.



Work sequence

Cutting.

Cut out all the details of the template along the solid line.

You will get the best result if you will cut the paper with a cutter by ruler. Please do not use scissors, because they can make dents on the paper in the turning places.

Folding.

Carefully score (but do not cut through) the paper along the dotted and dashed-dotted lines. This is necessary to make the folding of the paper in these place easier.

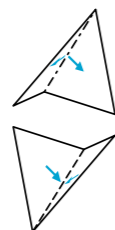

The dash-dotted lines denote folding of the paper to the outside (there are diverging arrows in this places);

The dotted lines appear in the places where the edges of the paper must be folded over to the inside (this movement is indicated by converging arrows).

Gluing.

The workplace have to be clean. If you stained your hands with glue, first wash them, then continue the assembly.

Fold all details along the lines.

The side of the paper with lines is the inner side of the model. The edges which should be glued together are denoted by the same numerals. For convenience, there are flaps for glue on the template (marked in gray). Start gluing together the edges from numbers «1», then «2», etc.



01

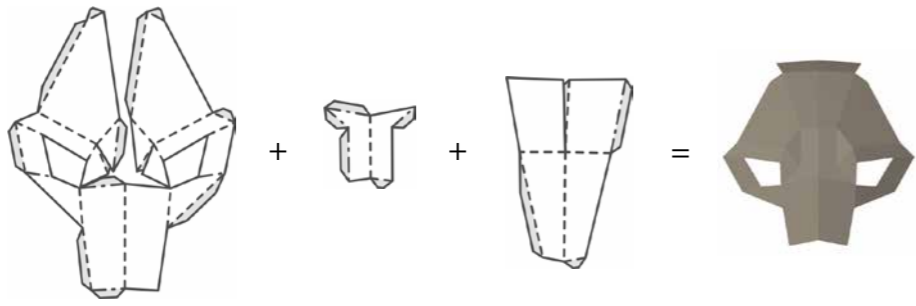

02

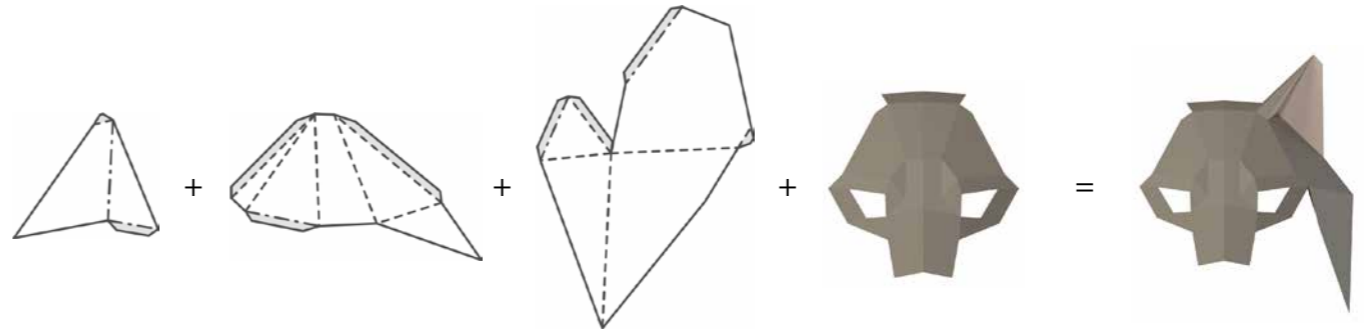

03

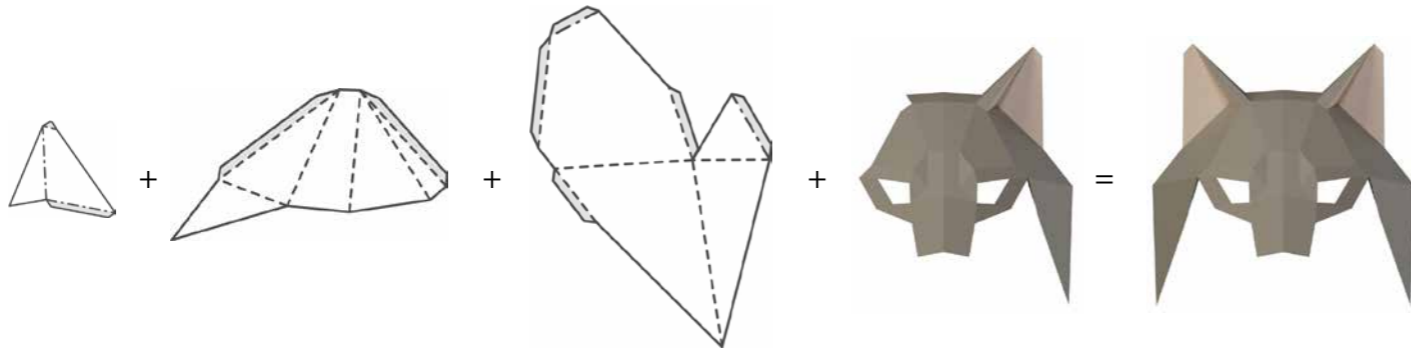

04

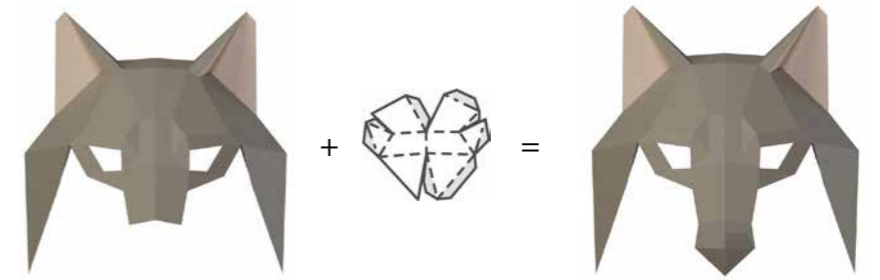

05

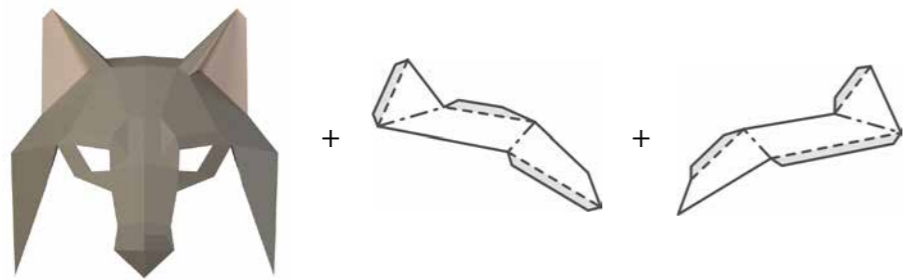

06

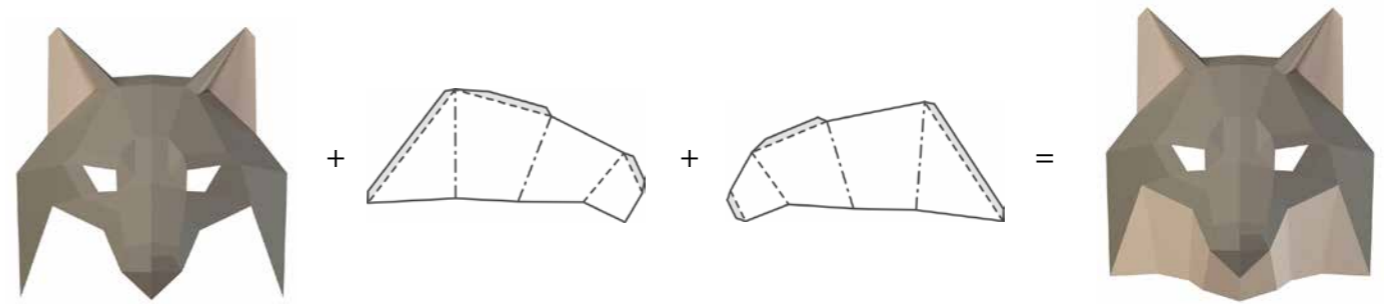

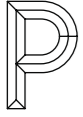

Thank you!