

Polygonal Paper

Instructions

on gluing paper birds





Author's note

Thank you for purchasing the files for making birds! You will need about 20 hours on gluing it. It is very difficult models. It is better if you have the skills of working with paper, but you can make a model, even if you have never done anything like this. In the first place, the result will depend on your attentiveness and exactitude.

Bird 1: 85 mm x 55 mm x 130 mm.

Bird 2: 115 mm x 190 mm x 100 mm.

Bird 3: 95 mm x 85 mm x 145 mm.

Video tutorial: <https://youtu.be/Y63wporZrkE>

I put a lot of effort into creating this model. It is forbidden to use any materials for the purpose of making profit, and also to share them.



Rim Shamsin, designer Polygonal Paper

✉ info@polygonalpaper.com

vk <https://vk.com/polygonalpaper>

f <https://www.facebook.com/polygonalpaper/>

ig <https://www.instagram.com/polygonalpaper/>

Bē <https://www.behance.net/polygonalpaper>



You will need for work



Sharp edged knife.

You can use any cutter for paper.



Metal ruler.

It's better to use the metal ruler, because this material is difficult to cut by cutter.



Glue.

that does not deform the paper. Metylan glue for wallpaper joints is suitable. UHU paper glue or Finnish carpentry PVA glue are also acceptable.



A surface for the cutting.

You can use a piece of old linoleum, or a glass panel, or a clean cutting board.



Thread for tie the birds



Template.

Printed on textured paper with a density of 180-250 gr/m², e.g. watercolor paper. For colorfull model, print the template on coloured paper. Please do not attempt to assemble a model with regular paper; the use of office paper leads to poor results.



Work sequence

Cutting.

Cut out all the details of the template along solid lines.

You will get the best result if you cut the paper with a cutter by ruler. Please do not use scissors, because they can make dents on the paper in the turning places.

Folding.

Carefully score or scrap (but do not cut through) the paper along the dotted and dashed-dotted lines. This is necessary to make the folding of the paper in these place easier.

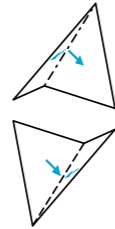

The dash-dotted lines denote folding of the paper to the outside (there are diverging arrows in this places);

The dotted lines appear in the places where the edges of the paper must be folded over to the inside (this movement is indicated by converging arrows).

Gluing.

The workplace have to be clean. If you stained your hands with glue, first wash them, then continue the assembly.

Fold all details along the lines. The side of the paper with lines is the inner side of the model. The edges which should be glued together are denoted by the same numerals. For convenience, there are flaps for glue on the template (marked in gray). Start gluing together the edges from numbers «1», then «2», etc.



Polygonal Paper

Bird 1

Assembly order

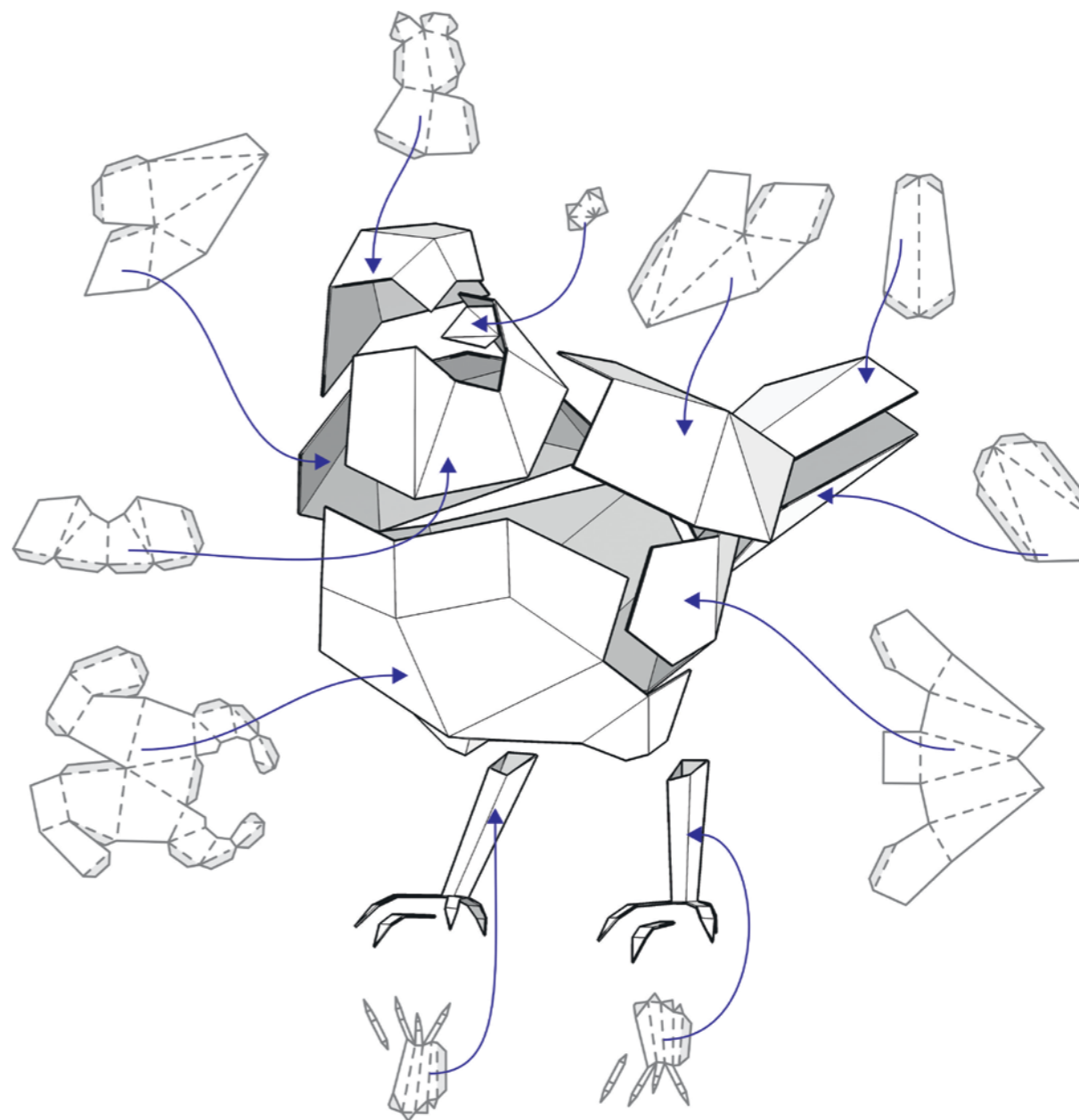

01

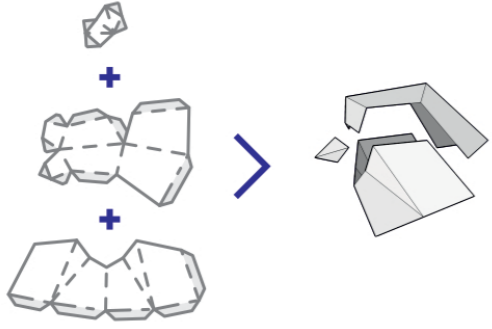

02

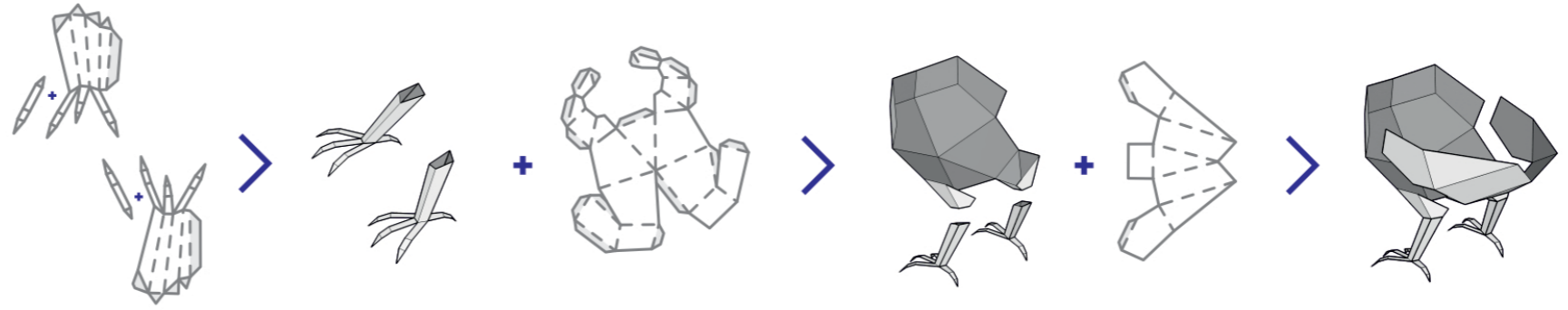

03

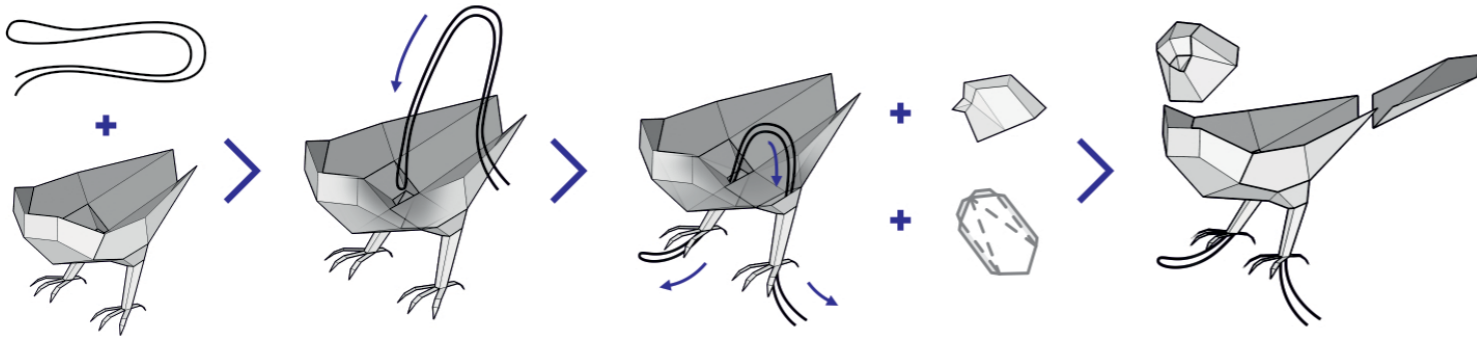

04



06

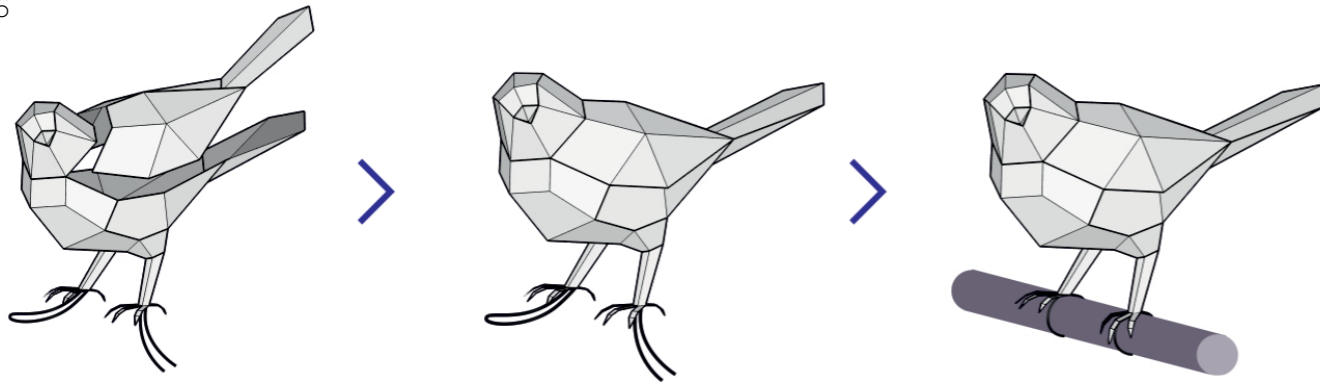

Polygonal Paper

Bird 2

Assembly order

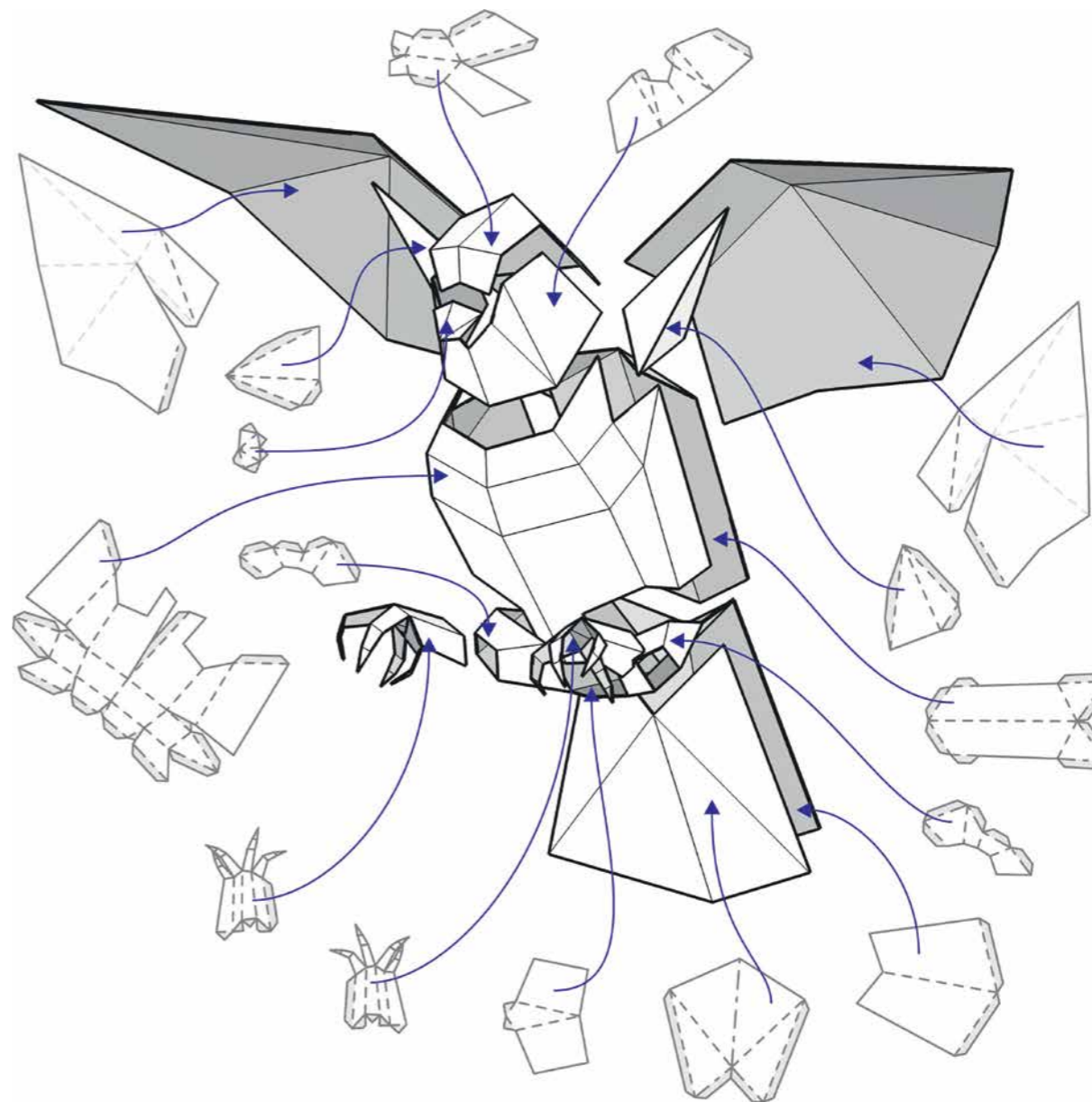

01

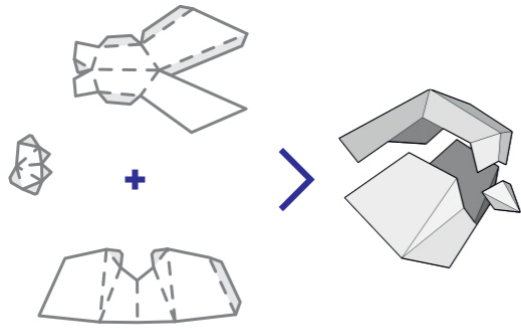

02

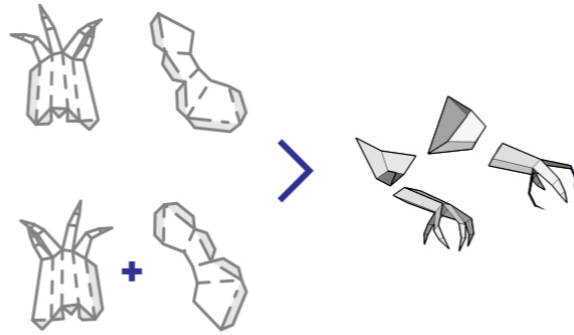

03

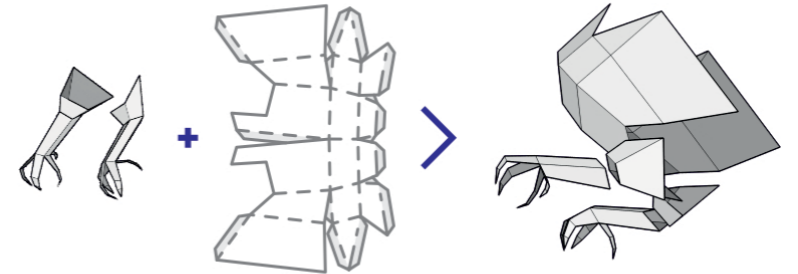

04

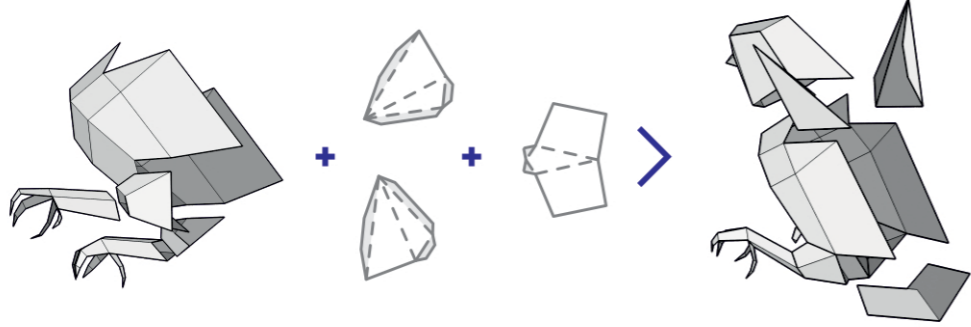

05

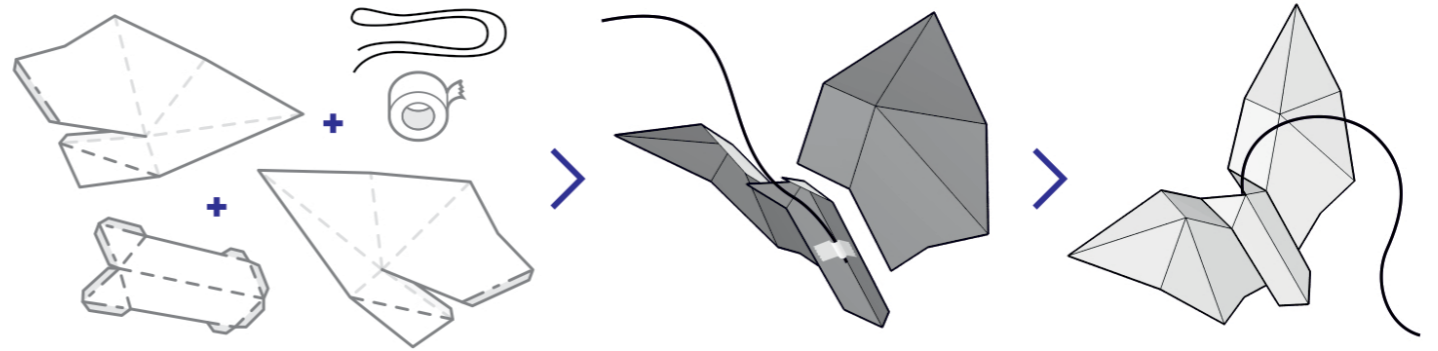

06

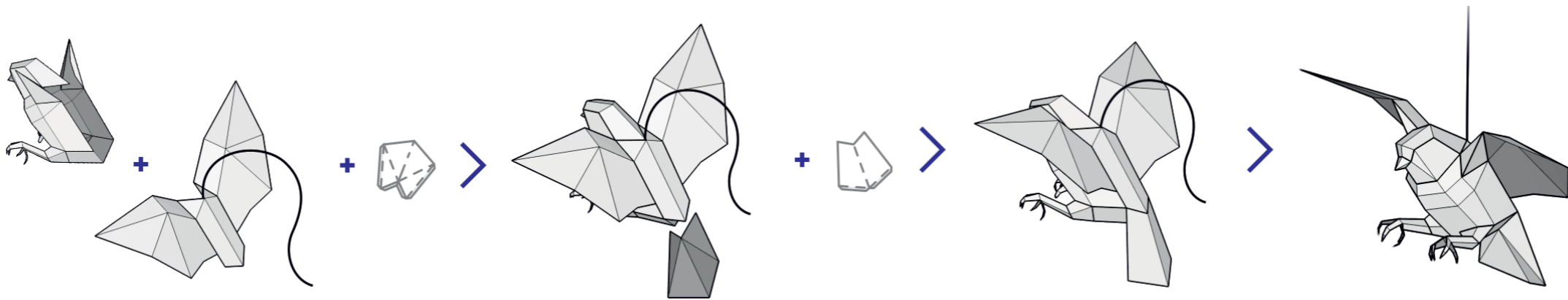

Polygonal Paper

Bird 3

Assembly order

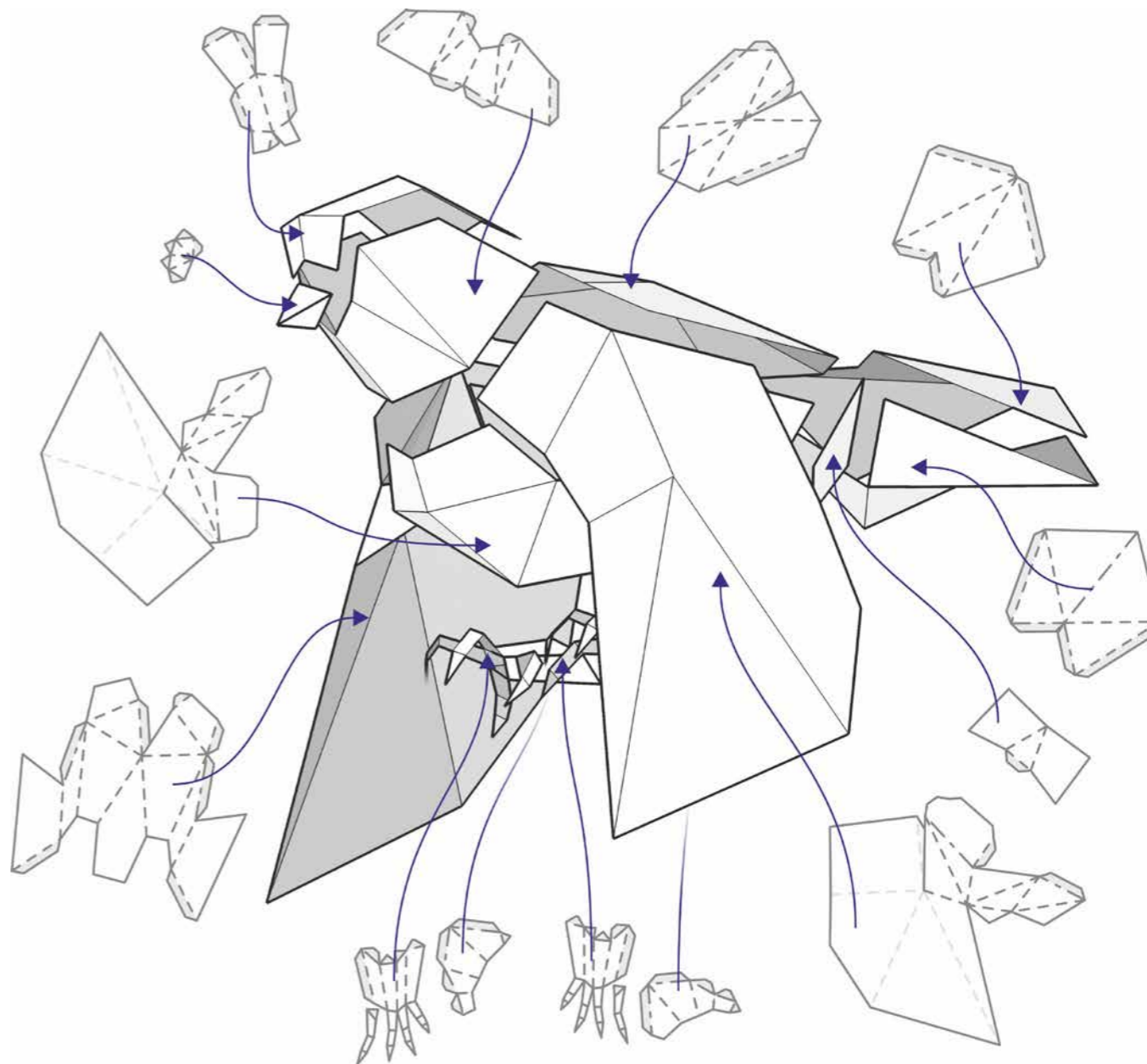

01

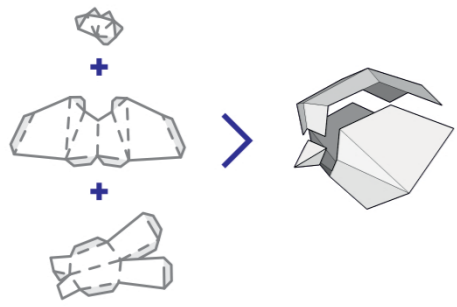

02

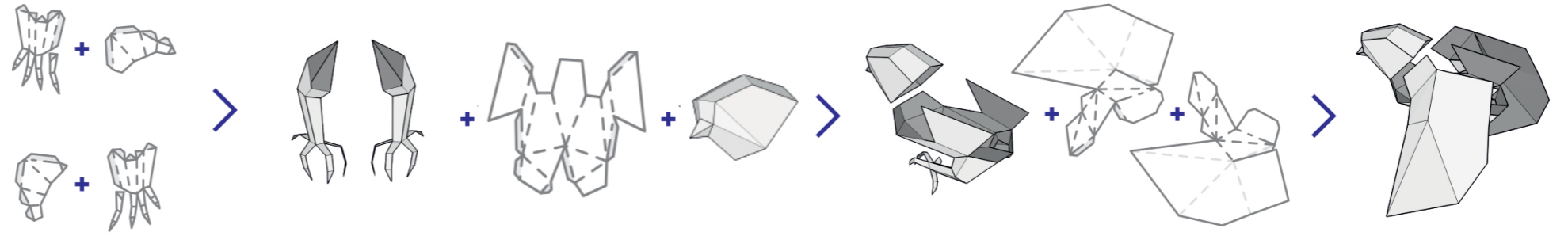

03

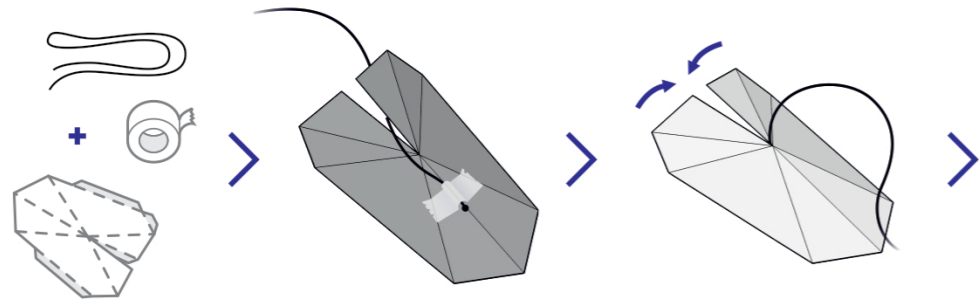

04

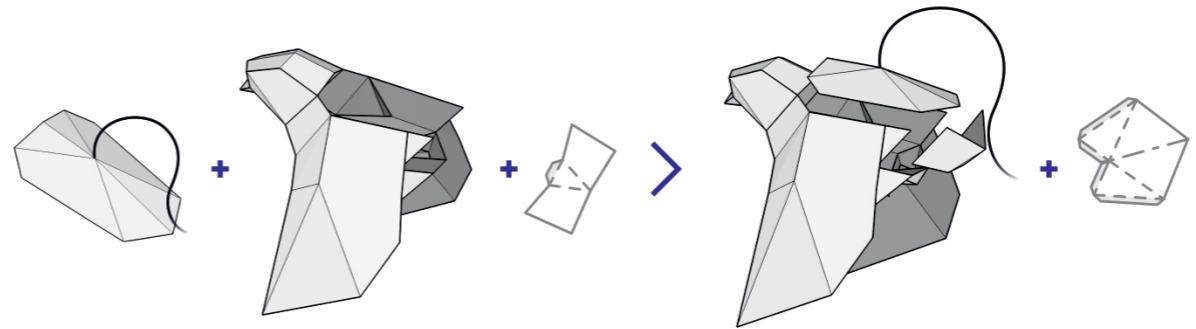

06

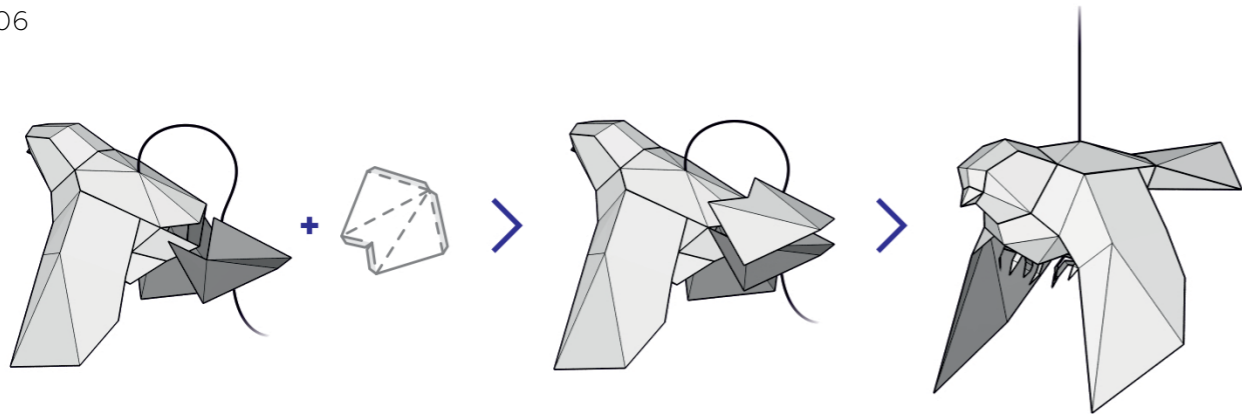

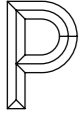

Thank you!